

ENGLISH FOR

Vocational Training Centers

Grade Two

(set by)

Ahmed Abd el Fattah Abd el Hady

Unit

(1) Changes



Aims of the unit

- Technological changes.
- Habitual actions in the present and the past.
- Revision (Present and past simple)

Revision

The present simple tense

A) Formation

the inf. with ,We,You,They

We go to Alex. For a holiday.

Add (ies/es/s) with.(He/She/It)

Ali/ He	Visit + s	Visits
Mona/She	Go+ es	Goes
My cat/It	Carry + ies	carries

add (es) If the verb ends with

(o/ s/ ss/ sh/ ch /x /z)					
Go	goes	Pass	passes	Finish	finishes
Watch	watches	Fix	fixes	Buzz	buzzes

add (ies) If the verb ends with (y) and there a consonant before

Cry	cries	Marry	marries
Hurry	hurries	Carry	carries

B:usage:

1-To express a habit

-He goes to school at 7.30 .

2-To express true facts

-Geologists study rocks.

-The sun gives us heat and light.

3-To express a state or permanent situation

-Hala works in abig bank.

4-Some verbs always take the present simple:

believe	يعتقد	forget	ينسى	hate	يكره
know	يعرف	like	يحب	mean	يعني
prefer	يفضل	see	يرى	seem	يبدو
understand	يفهم	want	يريد	love	يحب

tense markers

always	دائما	normally	عادة	usually	عادة
often	غالبا	sometimes	احيانا	generally	عموما
rarely	نادرا	seldom	نادرا	how often	كم مرة
Occasionally	من حين لآخر	frequently	غالبا	never	ابدا

-Waled sometimes comes late.

-Samy is always late.

On Friday, Sundays....	In summer, winter, spring, autumn ^٢
Once/ twice (a day/ a week)	Every day, week, month, year

Examples:

-We go to the club every Friday (on Fridays)

-Hanan goes to the school library twice a week.

-In summer, Hany takes exercises in the club.

-We usually visit Alexandria in august.

D) Negation

(He / She / It)

doesn't + inf

(I / We / They / You)

do not + inf.

-they don't play music on Friday.

-Reham doesn't go out every Saturday.

-I never drive my car during bad weather.

The past simple tense

A)Formation

The second form of the verb.

Regular verbs افعال منتظمة	Irregular verbs افعال غير منتظمة
1- باضافة (ed) لنهاية الفعل Visit visited	Cut cut Put put
2- باضافة (d) لنهاية الفعل اذا كان الفعل ينتهي ب (e) close closed	Buy bought Catch caught
3- باضافة (ied) لنهاية الفعل اذا كان الفعل ينتهي ب (y) قبله ساكن Marry married	Drive drove Ride rode Write wrote

B)usage:

1- to describe a past action:

-the ancient Egyptians built the pyramids.

-Dr Zewail discovered the femtosecond.

2-to describe actions in a story:

-On my way home yesterday, I saw an accident.....

-He got into the car and drove down the road.....

3-past habit: (used to + inf.) = (discounted past)

-In the past, people travelled on horseback.

-In the past, people used to travel on horseback.

C)tense marker:

yesterday امس / in the past في الماضي /formerly سابقا Last...../ago...../once...../ once upon a time.....

EX.

I visited New York two years ago.

We bought a new flat last month.

D) Negation: (didn't + inf.)

-He visited Luxor last year.

He didn't visit Luxor last year.

-Ali bought a new car yesterday

Ali didn't buy a car yesterday.

(be) used to + inf.	يستخدم ل / (صيغة المجهول)
---------------------	---------------------------

-A camera is used to take photos.

-A thermometer is used to measure temperature.

(be) used to + inf.	يستخدم ل / (صيغة المجهول)
---------------------	---------------------------

-sharp knives are used for cutting the beef.

-A microscope is used for examining very small things.

Unit(1)

Changes

1-Read the passage and answer the following questions

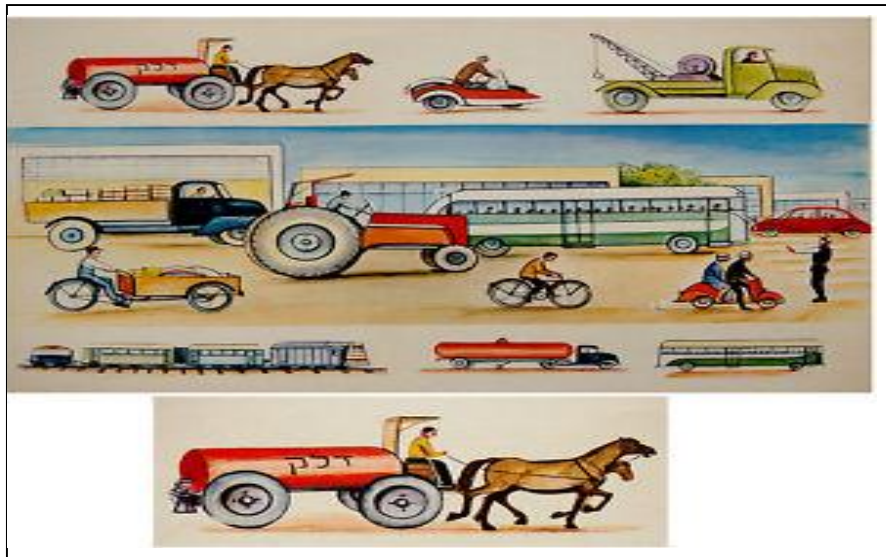

My grandfather said, 'in Cairo in the 1950s, I used to get up early and walk for two. hours to my friends house then we used to talk for many hours in a coffee shop. one day my sister was very ill and I walked to the post office and telephoned the doctor from there.

When I wrote to my brother in Port Said, he used to receive the letter three weeks . Later. When I visited my cousin in Alexandria, the bus (through Tanta) used to take almost one day. The bus used to stop in every village. We didn't have a TV or computer in those days, but we used to go to the cinema and the theater to see my favorite singer.

Mr.Mamdouh, our neighbor said, ' life in Cairo today is different. If I want to talk to.my friend, I use my mobile phone. I can phone from my home, or from my office, or from the street. If I want to write to him, I send him an e-mail from my computer, and he reads it a few seconds later. Every month I go to Alexandria to visit my sister the super jet bus (by the desert . road) takes only three hours, I watch TV every day and I watch a big number of satellite channels every week. I like to listen to my favorite singer, on my CD player".

Answer these questions:

1-Where did your grandfather's brother use to live?

2-Where does Mr. Mamdouh's sister live?

3-How can he listen to his favorite singer?

4-Where did they used to go to see their favorite singer?

Put (T) or (F):

1-life in Cairo today is easy. ()

2-Today,I can phone from my home or the street. ()

3- Cairo in the past was nice ()

4- Now you can travel easier than before ()

(c). The manager office is very modern. He is telling you what it was like ten years ago. Complete his words: use these words (used to-didn't use to).

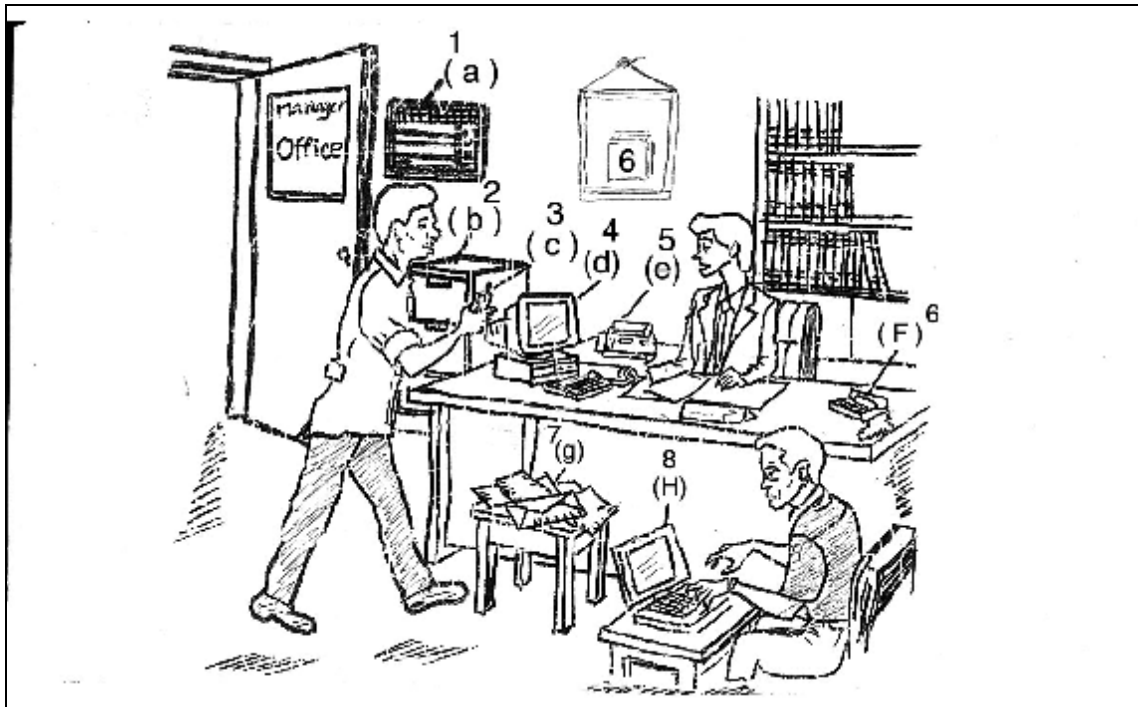

"This office is very modern now. Now it has an air conditioner and it is very cool, But in those days we(didn't use to)....have an air conditioner. It used to be very hot, So we(used to)....open the windows an switch on small fans. Now we have an international phone. In those days we.....have a telephone here. We.....walk across the road to a big hotel and we.....make the calls from there.

In those days the mail.....is very slow. But now we send express mail and it only takes one or two days.

Ten years ago we.....have computers. We....write everything on paper and we.....have many filing cabinets. Now we don't have many filing cabinets, But we keep all our files on the computer.

(D) Look at the picture of the manager office.

What are the objects called?

Use words from this list:

(Desk top computer; mobile phone; filing cabinet; international phone
; air conditioner; express mail; note book computer (lab top);
fax machine.

(E) Make sentences using the words below:

Example. (A) these days people often use mobile phones, and they often use public phones.

(B) These days' people often take taxis, but they don't often take the tram.

1-watch/TV ⇒ go/theatre

2-drive/car ⇒ ride/horse

3-write/e-mail ⇒ write/letter

(F)*Practice this:

In those days	I	used to	Watch TV
Then	We	didn't use to	Use computers
	They		Go to the cinema
	People		Write e-mails

Did	People they	Use to	Drive cars Take taxis Ride camels Use the net	Them? In those days?	Yes, they did No, they didn't
-----	-------------	--------	--------------------------------------------------------	-------------------------	----------------------------------

*In those days =1965-1973-1985-1990-1996

*These days; nowadays=2000-2005-2008...this year

G-look at exercise(E) again and make sentences:

Example. (A) In those days, they didn't use to write e-mails, they used to write letters.

(H)*Make questions and answer:

A-Did people use to take taxis. In those days?

B-No, they didn't, they used to take the tram.



Grammar

(used to+ infinitive)

(form)

Used to+ infinitive (express a habit in the past)

He used to live in a small house .He doesn't now.

Didn't use to+ infinitive (negative)

He didn't use to live in a small house. He does now

Did+ subject+ use to+ infinitive ? (the question)

(when)+did +subject +use to + infinitive?

Did he use to live in a small house?

When did he use to live in a small house?

(Use)

Used to+ infinitive is used

We use (used to) :

1-to contrast past and present habits:

_I used to play tennis every day.(I don't do this now)

2-to contrast past and present situations:

-I used to read daily newspapers.

(Remember) (habit in the present)

S +am/is/are+ used to+ verb+ in

He is used to working hard

S+is used to+inf.

_Scissors are used to cut cloth

S +is used for+V +Ing

Scissors are used for cutting cloth -

(Exercises)

Choose the correct answer from a, b, c or d:

1-In those days, he used to.....fishing.

- a)enjoy b)enjoyed c)enjoying d)enjoys

2-He.....to spend all his free time writing.

- a)use b)uses c)used d)using

3-Hatem is used to.....up early.

- a)get b)got c)getting d)gets

4-Yomna is used to.....things.

- a)buy b)bought c)buying d)buys

5-Tonges are used.....holding things.

- a)to b)for c)in d)by

6-A beaker is used.....hold liquids.

- a)to b)for c)in d) by.

Read the passage again and complete the table below:

	In those days.....	Nowadays
1-To talk to a friend	Walk to house	Mobile phone
2-To phone a doctor
3-To travel to Alexandria(route)	Through Tanta
4-To write to some one
5-to see a film
6-to travel to Alexandria(time)	Three hours

Remember the following:

(1)

used to + inf

Express past habit

-My father used to smoke when he was young

(But he doesn't smoke now)

-Heba used to live in Banha in the past.

(But she lives' in Cairo now)

(2)

when +subject +V

-When I was a child, I used to play in the street.

= I used to play in the street when I was a child.

(3)

There didn't use to be + noun

-There didn't use to be computers in schools 30 years ago.

Note

S + used to + INF	affirmative
Di+S+ use to+ INF	question
S + didn`t(=did not)use to + INF	negative

Examples:

1- A-Did your grandfather use to learn English when he was young?

B-yes, he did.

2- A-Did your grandmother use to travel a lot?

B- No she didn`t.

3- A-Where did you use to live before you moved to Giza?

B-I used to live in Tanta before I moved to Giza.

(A) Rewrite the following sentences to give the same meaning.

Change every verb:

Use these words :used to ;didn` t use to.

Example:

(a) In the old days, people walked to work every day.

In the old days, people used to walk to work every day.

(b) During the 1970s, office workers didn` t have computers. They kept all their files in filing cabinets.

(c) In those days, the journey to Alex. Always took one whole day.

(d) In the 1950s, the bus from Cairo to Alex. Always stopped in every village.

(e) Before you were born, your parents went to the cinema every week.

(F) Before the 1980s, people didn` t watch videos every day.

***Choose the correct response for these situations:**

(a) You are talking about last year`s holidays with your brother. You want to agree with what he says.

Your brother: we used to go swimming every day in the sea.

You:

A: Yes, we did.	B: Yes, we used.	C: No, we didn`t.	D: Did we?
-----------------	------------------	-------------------	------------

(b) You are talking with your friend about last year at school. You want to disagree with what she says.

Your friend: we didn`t use to work too hard.

You:

A: No, we didn`t.	B: Did we?	C: Yes, we did.	D: We didn`t use.
-------------------	------------	-----------------	-------------------

(c) You are talking with your father about when you were eight years old. You want to check that he is correct.

Your father: you didn`t use to like eating salad.

You:.....

A: No, I didn`t.	B: Did i?	C: Yes, I did.	D: Didn`t i?
------------------	-----------	----------------	--------------

Unit The computer &

(2) The internet

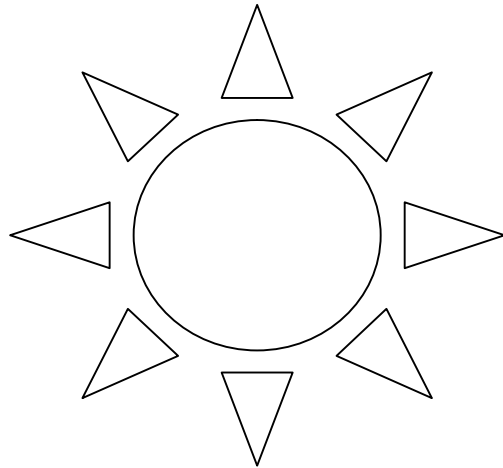

Aims of the unit

- Using smart technology.
- The importance of the computer.
- Continuous actions and the future.

Unit (2)

The Computer and The internet

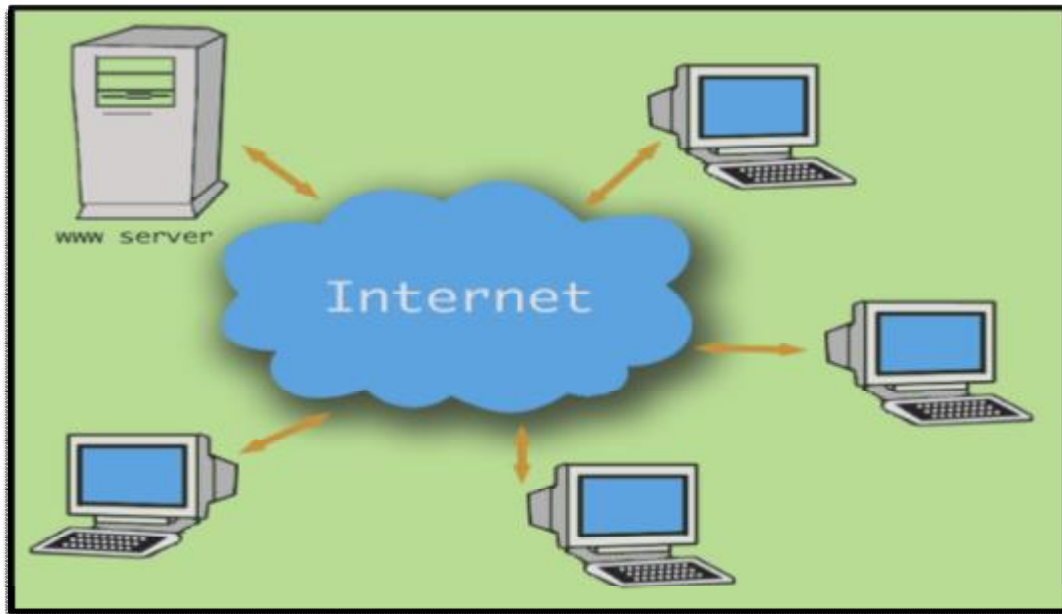

Read and Answer:

Nearly everything we do in the modern world is helped, or even controlled by computers. Computers are being used more and more extensively in the world today, for the simple reason that they are far more efficient than human beings. They have much better memories and can store huge amount of information, and they can do calculations in a fraction of the time. No man alive can do 500,000 sums in one second, but an advanced computer can. In fact, computers can do many of the things we do, but faster and better. They can pay wages, reserve seats on plans, control machines in factories, work out tomorrow`s weather, and even play chess.

Computers are everywhere today. At home, we use them to send e-mails and for the internet. In banks, computer stores information about people`s money. Factories use them to control robots that can do work which people did in the past.

Doctors use computers to help to examine their patients. Computers have made life easier for people. Computers are one of the wonders of the modern world.

A-Questions:

- Ø Give three reasons why computers are being used?
- Ø What do computer use for in factories?

B-Complete these sentences using a word from the list:

(Accurate / bodies / e-mail / memory / store / invented)

- 1-Computers were.....along time ago.
- 2-Computers are fast, flexible and.....
- 3-They a huge amount of information.
- 4-Doctors can take photographs inside our.....using computers.
- 5-We use computers to send.....through the net.

C- Put (T) or (F):

- 1-Computers were invented a long time ago. ()
- 2-Computers sometimes forget information. ()
- 3-In the modern world, everything is nearly controlled by computers. ()
- 4-In factories, computers are used to control robots. ()

D- Complete the following mini-dialogues

1-Madiha.....?

Mohamed: computers are important because they can work quickly and accurately.

2-Adel: Do computers have better memories than human beings?

Hani:

3-Ahmed:?

Abdo: yes, they store a huge amount of information.

Part (2)



Read the following passage then answer the questions:

There are millions of cheap computers in offices and homes across the world. In some countries, many ordinary people have bought one more computers, which are connected by the internet to shops, banks and offices.

More and more people are shopping, paying their bills, studying and doing many other things by computer.

Well, computers certainly concern people, so much so that perhaps people should be concerned about the growing power of computers. Will they come to control us completely? A computer expert has the last word. Computers do work extremely fast, and may seem very clever to us, but in fact they can only do what they are told. We tell them what to do.

Computers are only as good as the program fed into them. It's up to us to decide what we want to use computers for. They are our servants, and not our masters-yet.

A-Questions:

- ü Why do people connect computers by the internet?
- ü Will the computers come to control us completely?

B-Complete the following sentences with a word from the list

(Cost / shopping / shop / ordinary / cheap/ expensive)

- Computers were much more.....and bigger than they are today.
- Many.....people can buy computers now as they are so cheap.
- In the past, computers a lot of money.
- Now, more and more people are.....by computer.

C-Rewrite the sentences and correct the mistakes:

1-Computers cost a little money in the past.

2-They do work very slowly.

3-Computers tell us what to do.

4-People cannot shop or study by computer.

D-Grammar:

(The present continuous tense)

From: am\is\are + verb + ing

Use: action which are going on at the moment of speaking.

It`s often used with:

Now-at this moment-at present time-look!-listen!-still!

Ex. It is raining at this moment.

Ex. We are enjoying our lunch now.

Ex. Listen! She is playing the piano.

Note!

It`s also used to indicate a future event which is already fixed or arranged.

Ex. Sara is arriving tomorrow.

Ex. Mo`men is leaving in two days.

E- Correct the verbs between brackets:

1-listen! She (sing) beautifully.

2-he (plays) computer games at this moment.

3-look! A bird (fly) up the tree there.

4-Ola (arrive) tomorrow.



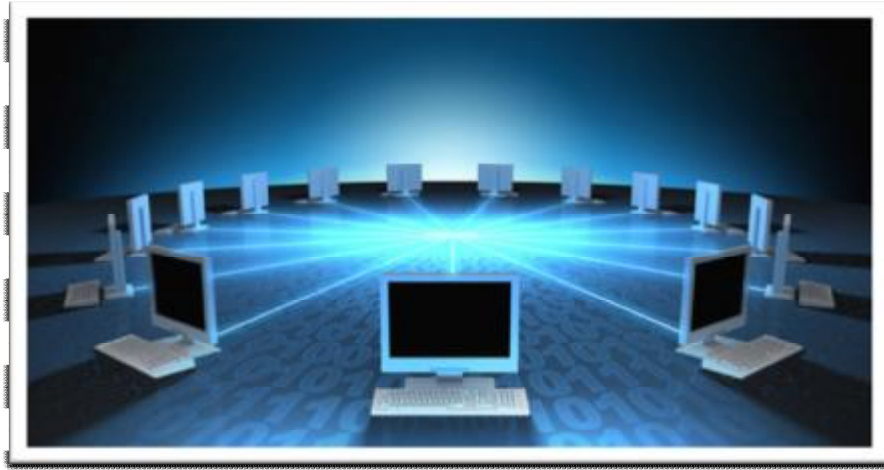

Read quickly then answer the questions below:

These days, many people go on line for one thing or another. For them, the internet has already become a part of everyday life. So what is the internet and the world wide web? The internet is a network made up of millions of computers around the world. It is not located in one specific place. There is also no-one in charge of the internet. And anyone can be a part it. The World Wide Web is a collection of web sites or pages accessed from a computer. This is what is meant by people going ``on line``. To get connected, you first need a computer, a modem and a telephone line. Telephone companies and private businesses provide access to the internet. Now you can communicate with other computers worldwide.

You also need an online service. In some countries, this service is free. In other countries, you will have to pay for an online service. Lastly, you need a browser for your computer. This is a computer program that enables you to move around the internet.

From this, you can search for information and visit websites online.

A-Questions

- Ø Do you know what the internet is?
- Ø What do you need to do to log onto the internet?
- Ø What does "www" stand for?
- Ø How can you move around the internet?

B-Complete the following mini-dialogues

1-Yara:

Salwa: yes, the internet can be dangerous.

2-Essra: are you connected to the internet?

Radwa:

C-Put (t) or (f):

- Most people go online. ()
- The internet is part of everyday life for everyone. ()
- It can't be educational and fun. ()
- Sometimes, the internet isn't safe. ()
- Most people communicate by e-mail. ()

D-Choose the correct answer from a-b -c:

1-The internet has already become a part of.....life.

A-long b-everyday c-sometimes

2-From the internet you can.....for information.

A-search b-log c-serve

3- The internet can be

A- Beautiful b – famous c- dangerous

Part (4)



Read then answer the questions below:

The internet is a great way to learn about many new things. It can be educational and fun. But be careful! The internet is a network of millions of computers all over the world. You don't know if the people you meet on the internet really are who they claim to be. In fact, sometimes they are not! So,

To stay safe, it's important to follow these simple safety steps:

- Never give out personal information like your name, address and telephone number.
- Never give out online passwords.
- Never agree to meet someone you have "chatted to" on the internet.

Meeting people like this can be very dangerous. Tell your parents about what you do online and who you spoke to. It is important that they must know the web sites you visit and the information you are getting.

A-Questions:

- 1-Should you give out any personal information over the_ internet?
- 2-What should you do if someone you chat on the internet_ wants to meet you?
- 3-Does everyone like to "chat" online?
- 4-Do you need a telephone line to be connected to the_ internet?
- 5-Why should you be careful when you meet the people on the internet?

B-Rewrite the sentences and correct the mistakes:

- 1-The internet is a network of two computers all over the world.
- 2-You can buy anything online without your parents` permission.
- 3-The internet is a boring way to learn about many new things.
- 4-Never give out off line passwords.
- 5-The internet has information about nothing.

C- Communication:

- You are going to talk about satellite television programs.
- Read this e-mail to a magazine for young people then with a partner.

http://				
Send	attach	address	replay	delete
To:				
From:				
Subject: satellite TV				
Hi,				
I've just read about satellite TV in your magazine. I found it very interesting and I'd like to give you my opinions on this subjects.				
I believe that satellite television is a good thing, because it brings more interesting programs from around the world into our homes, especial live sport.				
But it's no good, if people spend more time watching TV as there are more programs to choose from.				
People need to spend more time doing things.				

A-Tick any points you agree and you disagree with.

B-Write notes in answer to these questions,

- 1-Which satellite channels can you watch in Egypt? (Dream-art)
- 2-What kind of programs can you watch? (News-films-sport)
- 3-What kind of programs you like to see on satellite channels in the future? (Educational-more plays)

C-Grammar The simple future tense

Form: *will + infinitive

*won't + infinitive (Negative statement)

*When will you arrive? ... (Wh-questions)

*Will he be late? (Yes/no questions)

Yes, he will no, he won't (short answer)

Use: predictions: I expect Samy will arrive today.

Future facts: it's his birthday next Monday. He'll be 16.

Quick decisions: the door bell is ringing. I'll open it.

Offers: I'll make dinner tonight.

*Correct the verbs in brackets:

1-We (start) the exam next Monday.

2-You (join) the army next year.

3-She (buy) a television set tomorrow.

4-Our team (play) a match tomorrow evening.

5- In the future we (travel) abroad .

*Choose the right answer from a,b or c

1-Tomorrow, Rania.....visit me.

a-will

b-could

c-have

2-Sara will.....the doctor next Thursday.

A-see

b-seeing

c-saw

Unit

(3) Inventions



Aims of the unit ◉

- The effect of inventions on human being.
- Advantages & disadvantages of inventions.
- The present perfect.

Unit (3)



Ahmed and Magda are talking about inventions

Ahmed: Which invention is the most important invention in your life?
And why?

Magda: In my opinion, the most important one is the mobile phone,
because people can communicate with each other when they
are not in the same place

Ahmed: Do you think that the telephone has brought many problems
however, it has also brought happiness?

Magda: Yes, It can make people lazy they may telephone friends instead
of visiting them

A-Complete the following mini-dialogues:

1-Hady:

Nour: Thomas Edison invented the phonograph

2-Sara: What is a patent? Why does an inventor need to have one?

Gana: A patent is

B-Put the correct word in the following spaces:

(Television – Pipes – happiness – invention)

1-Inventions have Brought people many.....

2-An.....is a discovery or new way to make some thing

3-In my opinion, the.....is a great invention

C-Tick (T) or (C):

1-Inventions have brought people-only problems ()

2-The telephone help us to communicate ()



Part (2)

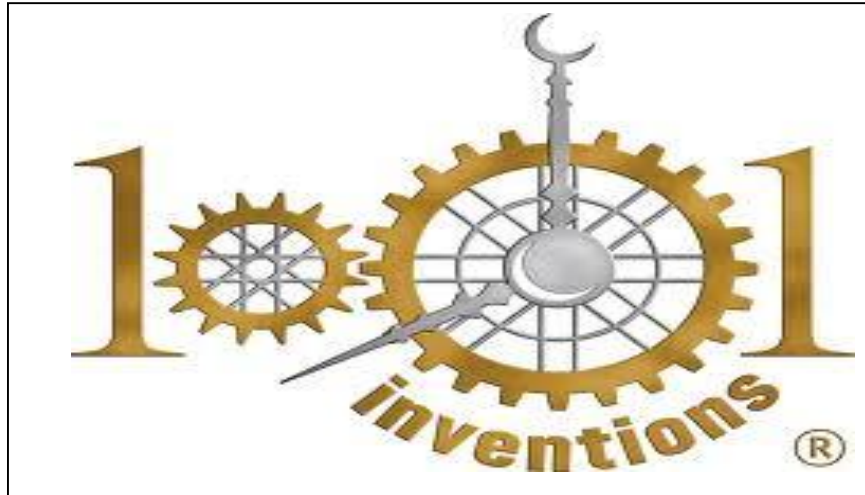

Read the following passage, and then answer the following question:

People invent things for many reasons. For example, the television was invented to bring people news and interesting-information. it teaches them new things and shows them, also, places they will never visit.

During the last hundred years, there have also been enormous advances in the field of inventions; Engineers have designed cars that use batteries beside petrol. When the battery is empty, the petrol engine takes over, and when the car uses petrol, this recharges the battery. This car can go farther using the same amount of petrol as ordinary cars.

Scientist has also discovered that cars can run on vegetable oil; it is another cheap source of fuel for this unique cars. This means that we should try to find new ways to make and use power.

Solar cars get their energy from the sun. Electric cars run on electricity. The inventors wanted to get the best petrol-mileage possible.

A-Questions:

1-How are cars that use engines and-batteries better than early electric cars?

2-What kind of fuel does a car need to-make it runs?

3-What May car batteries use in few-years time?

4-Can cars use oil made from vegetablesc, these days?

5-How do some cars use petrol and batteries together?

B-Complete the following mini –dialogue

1-Yara: Are the inventor’s clever people?

Sama:.....

2-Heba:.....

Ola: yes, solar cars run on sunlight.

C-Choose the correct answer:

1-A solar car uses..... for energy

A-electricity b-petrol c-the sun

2-Gas, coal and oil are.....resources

A-man-made b-natural c-expensive

3- When the battery is empty , the engine takes over.

A- petrol b- water c- sun

4- Some modern cars can run on oil

A-vegetables b- fruit c- water

Grammar

The present perfect tense

1-This tense is used to describe an action which:

A-Took place an indefinite past time but whose effects are still evident in the present

B-Began in the past and still continuous

C-Have happened recently

D-Have not happened yet

E-Questions about someone's experience

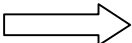
2-Form: I\you\we\they  (have +p.p)

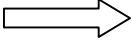
He\she\it  (has +p.p)

3-use the following to describe the present perfect

(Just\already\yet\never\ever\recently\up till now\so far\lately)

For + period of time (an hour-three days)

Since+ appoint in time (two o'clock-yester day)

Ex. He has written four letters this morning

Ex. I've lived in Giza since 1985 \ for 27 years

Ex. She's just finished her home work

Ex. we have never played tennis

Ex. Have you ever been to Paris?

Questions

- What have you done this morning?
- How long has your uncle lived in Cairo?
- Have you seen that film yet?
- Has he sent me an e-mail this morning?

Exercises

A-choose the correct verbs in brackets.

1-The new student.....very well so far

(a-behaved b-have behaved c-behave)

2-I.....there for ten years.

(a-has worked b-worked c-have worked)

3-He has just.....his first year

(A-finishing b-finished c-finishes)

4-we have.....in Giza since 1989.

(A-lived b-live c-lives)

B-fill in the space by using:

(yet-already-since-for)

1-He has been in prison.....a year

2-She has worn the same hat.....1985

3-Amr has.....visited the museum

4-The train has not arrived.....

5-sara has.....washed the clothes.

Communications

1-Discuss in Pairs.

- What are the advantages and disadvantage of some inventions? Which invention is the most important in our life today? Why?
- Which is the least important? Why?
- Do inventions bring problems as well as happiness?

2-Read the first paragraph of a composition (part 2).then make notes about an invention you want to talk about, like this.

Inventions: Radio

Advantages:

- 1-it tells people news and interesting information
- 2-it brings them the latest news.
- 3-it teaches them new things
- 4-it's easy to carry wherever you are



Disadvantages

- 1-People listen to things instead of watching them
- 2-It can be bad for your ears
- 3-It can sometimes be difficult to find a radio station
- 4-When you've found the station it's sometimes difficult to hear

Unit (3)

Inventors and their inventions (3)



Mrs. Eman our English teacher is telling us some information about the most famous inventors. She said that we should be grateful to them. Because we owe much to their inventions which make us lead a happy and comfortable life. Thanks to their work we have all means to comfort which satisfy our needs. Those great characters enable us to have life full of beauty and charm. You should put in your mind that they suffer a lot. They exert a great efforts to overcome huge obstacles and defeat the difficulties they faced. To help us lead

welfare life please, here by some notes about some famous inventors and their great inventions.

Charles Babbage,

was an [English](#) mathematician, philosopher, inventor and mechanical engineer who originated the concept of a programmable computer. Considered a "[father of the computer](#)",



Alexander Graham Bell

was an eminent scientist, inventor, engineer and innovator who is credited with inventing the first practical [telephone](#).



Louis Braille; was the inventor of [Braille](#), a system of reading and writing used by people who are [blind](#) or [visually impaired](#). As a small child, Braille was blinded in an accident; as a boy he developed a mastery over that blindness; and as a young man – still a student at school – he created a revolutionary form of communication that transcended blindness and transformed the lives of millions



Sir Alexander Fleming

(born 7 August 1881 – 11 March 1955) was a Scottish [biologist](#), [pharmacologist](#) and [botanist](#). He wrote many articles on bacteriology, immunology, and chemotherapy. His best-known discoveries are the [enzyme lysozyme](#) in 1923 and the antibiotic substance [penicillin](#)

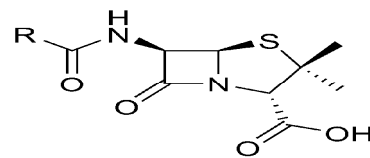

Guglielmo Marconi

(Italian pronunciation: ɡuʎiɛlmo maˈɾɔni) was an [Italian](#) inventor, known as the father of long distance [radio transmission](#)^[1] and for his development of [Marconi's law](#) and a [radio telegraph](#) system. Marconi is often credited as the [inventor of radio](#),



Marie -Curie, often referred to as Marie Curie or Madame Curie

was a Polish [physicist](#) and chemist, working mainly in France, who is famous for her pioneering research

on [radioactivity](#). She was the first woman to win a Nobel Prize

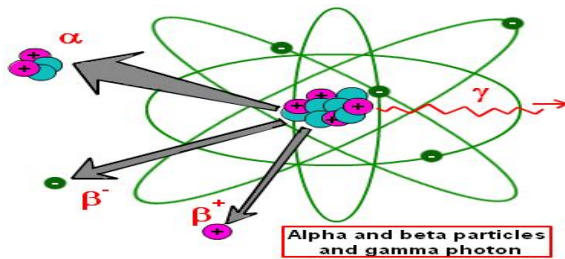
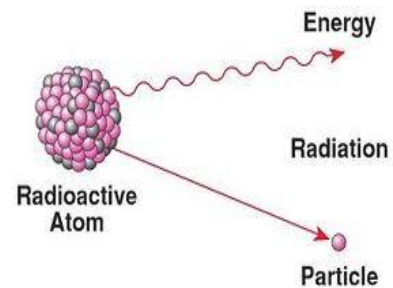

The Wright brothers

, were two American brothers, inventors, and aviation pioneers who were credited^{[1][2][3]} with inventing and building the world's first successful [airplane](#) and making the first controlled, powered and sustained heavier-than-air [human flight](#), on December 17, 1903. In the two years afterward, the brothers developed their [flying machine](#) into the [first practical fixed-wing aircraft](#). Although not the first to build and fly experimental aircraft, the Wright brothers were the first to invent aircraft controls that made fixed-wing powered flight possible

Thomas Alva Edison

an [American inventor](#) and [businessman](#). He developed many devices that greatly influenced life around the world, including the [phonograph](#), the [motion picture camera](#), and a long-lasting, practical electric [light bulb](#).

EXERCISE

(A) Answer the following questions :

- 1- Why should we be grateful to the inventors?
- 2- Do you think that the inventions make us happy?
- 3- What should we put in our minds concerning the inventors?
- 4- Did they face any problems?
- 5- How did they overcome these problems?

(B) Complete the following sentence using a word from the list:

(bike – invented – radiology – plane – Graham bell – Marconi)

- 1- ----- invented the telephone.
- 2- Radio was invented by -----.
- 3- Mari Cori invented -----.
- 4- Edison ----- the lamp.
- 5- The ----- was invented by wright brothers.

(C) Complete the following mini –dialogues:

1- H: who invented the first computer?

M: -----.

2- S: what did the wright brothers invent?

A: they -----

3- O: ----- ?

N: Edison invented the lamp.

(E) Match the following:

A

B

1- The telephone was invented	A- by write brothers.
2- James watt invented the	B- the first computer.
3- The first plan was invented	C- by Graham bell.
4- Charles Babbage invented	D- internal combustion engine.

(F) Translate into Arabic:

1- We owe much to inventors and their inventions.

Translate into English:

١- تجلب الاختراعات السعادة للإنسان .

٢- اخترع الاخوان رايت أول طائرة .

Unit

(4) Energy



Aims of the unit:

- The importance of energy.
- Kinds of energy.
- The comparison .
- The conditional sentence.

Unite (4)

Energy (1)



Read the passage and answer the questions below:

Nothing can live without energy. Energy is very vital for life. There are different forms of natural-energy. These sources give us light and power in our homes and industries some of these forms will last forever as the sun, the water and the wind. These are called renewable energy. Most of the energy we use in homes and at work comes from fossil fuels, as coal, oil and natural gas, these forms will run out soon. These forms are called non-renewable fuels for this reason.

The world must reduce the amount of non-renewable fuels and find different forms of energy.

Renewable energy comes from the sun, the wind, the water and from rubbish. Wind farms are connected to turbines to generate electricity. Huge amount of water that fall through the turbines help generate electricity there is –also- another clean and important form of energy. It's nuclear (atomic) energy which is used to produce electricity. But it's most- expensive and dangerous.

Most of our energy-also-comes originally from the sun. this kind of energy can be turned into-electricity or heat .it's called "solar energy"

The Questions:

- 1- What are forms of renewable energy?
- 2- Why must the world reduce the use of non-renewable fuels?
- 3- Mention three forms of energy we use at work and in-homes?
- 4-What are the disadvantages of nuclear energy?
- 5-Can anything live without energy?

(A) Choose the correct answer:

1. Rubbish is ----- source of energy nowadays.
A-useless b-useful c-dangerous
2. We must ----- the amount of non-renewable fuels.
A-Waste b-reduce c-increase
3. The wind is used to ----- electricity.
A-Make b-burn c-generate
4. Coal, gas and oil are all types of -----.
A-Fuel b- food c-chemicals
5. ----- energy doesn't run out.
A-Knowable b- renewable c- electric
6. Solar energy comes from the -----.
A-Sun b-earth c- wind
7. We need energy to work and -----.
A- Travel b-run c-live
8. ----- use water to generate hydro electricity.
A- Wheels b-factories c- turbines
9. ----- refer to the power we get from the sun.
A- Nuclear b- solar c- hydroelectric
10. The energy available for us has different-----.
A- Farms b-frames c-forms

(B) Complete the following mini-dialogues:

(1) Ahmed: -----?

Teacher: The forms of natural energy are water, sun and wind.

(2) Fatma: what is meant by hydro-electric power?

Reda : -----.

(C) Tick (T) or (F):

- 1- Cars run on petrol. ()
- 2- All our energy comes from the sun. ()
- 3- Energy comes in different forms. ()
- 4- Hydroelectric power stations generate electricity. ()



Energy (2)



It is important to save energy by turning off the lights when leaving a room, in switching off TVs and computer after using them, and buying products from recycled materials.

The world is running out of oil, and energy experts believe that there could be serious shortages in ten years 'time. Not only is each individual using more oil than ever before, as the standard of living in industrialized countries rises, but the population explosion means that each year many more people will be using oil in some form or other.

Government are searching for a suitable alternative, they are considering how they can make better use of the natural gas. It's the purest fuel, is also the most limited in supply.

The answer would seem to lie in nuclear power-stations. They need very little fuel to produce enormous amounts of power and they don't pollute the atmosphere their dangers, however, are so great and the cost of building them so high that some governments are unwilling to invest in them.

(A) Complete the following mini-dialogues:

(1) Seif: Is it safe to produce energy from atom?

Father: -----.

(2) Reporter: -----.

Scientist: they need very little fuel to produce enormous amount of power and they don't pollute the atmosphere.

(B) Choose the correct answer:

- 1- Badly managed ----- power stations are extremely dangerous.
A-magic b-atomic c-automatic
- 2- Nuclear----- is dangerous and it must be carefully stored.
A-lost b-waste c-miss
- 3- Using nuclear energy ----- behind dangerous waste.
A-leaves b-lives c-gives
- 4- Nuclear energy is a clean ----- source of electricity.
A-renewable b- decayed c-cheap

Grammar

Comparison of adjectives

(A) Regular comparisons:

- 1- Adj., of one syllable: add (----er/-----EST.)
Tall -----à taller than -----à the tallest
- 2- Adj., of three or more syllables : use more / the most
Interesting -----à more interesting -----à the most interesting

Note:

- 1- If the adj., of two syllables ends in - à (le) add (----er/----- est.)
- 2- If the adj., of two ends in ----à (y/-/y) change the (y to I) and add /er/or/est.
- 3- the adj., of two ends in (-----er) compares two ;
The adj., ends in (----est.) compares more than two.

(B) Irregular comparatives

positive	comparative	Superlative
Good/well	Better-----than	The best
Bad/ill	Worse----- than	The worst
little	Less----- than	The least
Many/much	More----- than	The most

Grammar:

Equality

(A) (as + adv. /adj. + as)

Ex. He is as old as I am.

Ex. She locked the door as quickly as she could.

(B) In the negative ,

1- (not as + adv. /adj + as)

2- (not so + adv. /adj + as)

Ex. Hany is not as intelligent as Tarek.

Ex . The village is not so crowded as the city .

Exercise

Correct the following adjectives:

- 1- It is cool today; yesterday it was (cool).
- 2- This test is (easy) than that one.
- 3- Sara is (beautiful) than her sister.
- 4- Yara is the (thin) girl in class.
- 5- He ran (quickly) as he could.

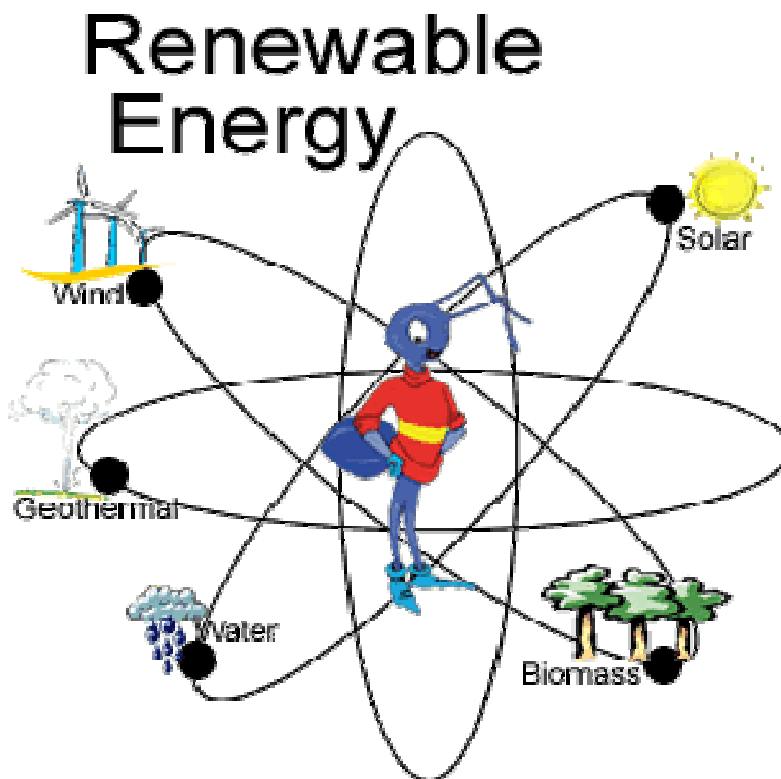

Energy (3)



Read the text and answer the following questions:

There are several alternatives to nuclear power such as, the sun, the wind and hot springs .of these the sun seems the most promising source for the future. But the energy from the sea and wind won't be a suitable solution to a future energy crisis; the first because a lot of energy is needed to be generated energy from the sea, and the second because the amount of energy generated from wind satisfy only a small percentage of a nation's needs.

If the world population goes on increasing at its present rate, and each individual continues to use more energy every year, we may, in –less-fifty years 'time ,be burning up so much energy and damage the earth's atmosphere scientists continue their experiments to avoid these dangers. We can all help to protect the environment by not wasting energy.

Questions:

- 1- Are there any alternatives to nuclear power?
- 2- Mention two of these alternatives ?
- 3- what is the result of the increasing of energy use?

(A) Match the two halves of the sentences:

(A)	(B)
1-The sun seems, the most	A-To protect the environment
2- it's important to know how	B-we may damage the earth's - atmosphere
3-wind farms trap the wind	C-to save our natural energy.
4-if we use more energy	D-and use it for energy.
5-solar energy is also used	E-promising source of energy.

(B) Complete the mini-dialogues:

- (1) Reporter: could you give us examples of from of energy- that'll never run out?
Scientist: yes, sure-----.
- (2) Hady: -----?
Fady: we can all help to protect the environment by not wasting energy.

(C) Tick (T) or (F):

- 1- There are many alternative to nuclear powers. ()
- 2- A lot of energy is needed to generate energy-from the sea. ()
- 3- World population doesn't cause energy crisis. ()

(D) Translate into Arabic:

- 1- One of the environmental problems is the slight rise in the temperature of the earth.
- 2 - When we recycle rubbish, we protect our environment.

Translate into English:

- ١ - تسعى جميع دول العالم للاستفادة من الشمس كمصدر متجدد للطاقة.
- ٢ - يوجد بدائل متعددة للطاقة النووية.



The conditional statements

- Type (1)

(If + present simple -----à future simple)

Ex. If he is out, I'll call tomorrow.

Ex. You'll miss the bus if you don't hurry.

- Type (2)

(If + past simple -----à should/would/could/might + inf.)

Ex. If you had a lot of money, you'd buy a car.

Ex. If he studied hard, he could pass the exam.

- Choose the correct answer:

1- If he does come early, the teacher ----- him.

a- Punishes

b- will punish

c-punished

2- If I ----- in his place, I'd do the something.

a- Were

b-are

c-am

3- If our team played well, they-----the match.

a- Win

b- will win

c-would win

Unit

(5) Safety rules



Aims of the unit ◦

Safety precautions.

Giving warnings.

Avoiding accidents

The past perfect

Unit (5)



Safety rules(1)

(A)Read the following passage then answer the questions

Men working with machines, sharp tools, motors, electricity or inflammable material must always be careful and always on guard.

They must do what they are told so as to avoid accidents. The things they do to avoid accidents are called safety precautions. To save his eyes, the welder must use his mask. The mask may make his face hot but it is better for him to be uncomfortable than to hurt his eyes forever. The electrician must check that the current is turned off before he starts to handle radios and other machinery. The fitter must use a machine with guards on the moving parts where his clothing may catch.

Those who work near or with inflammable material must always have the thought of fire in the back of their minds. They must not smoke or strike matches.

These are somethings we can all do to avoid accidents wherever we work or whatever we work at. We should always keep watch on

machines, for we are the brain of the machine; they cannot think and when something goes wrong, they will not stop. We must avoid loose clothing which might get in machines and take us against the machine.

Accidents happen more frequently when we are tired towards the end of the working day. That is the time to be especially careful and to see that all safety precautions are taken.

(A)Questions:

- 1-What are safety precautions?
- 2-What must a welder use to save his eyes?
- 3-What must the electrician check?
- 4-How could a fitter avoid accidents of the moving parts of a machine?
- 5-In what way those who work near inflammable material be safe?
- 6-Can machines think?
- 7-What is man to machines?
- 8-When do accidents happen more frequently?
- 9- What is our duty then?
- 10- Why must we be careful when we work with machines ?

(B) Practice two ways of giving a warning to others:

(1) Tell them there is a hazard:

There's	a ladder fire a hammer an axe 	In On 	the wall the work shop the bench the floor The machine
	cover no guard	on	

There are	ladders fires hammers axes 	in on 	the wall the work shop the bench the floor the machines
	covers no guards	on	

(2) Tell them something might happen:

You	Could	cut	your	hand
He	might	burn	his	leg
She		injure	her	foot
		hurt		head
		bump		

(C) Match the following sentences:

(A)	(B)
1-Men working with machines	A-always walk
2-the thing we do avoid accident	B-when you work near inflammable materials
3-Don't run in the workshop	C-we should be careful
4-You must not smoke or strike matches	D-must be careful and always on guard
5-at the end of the working day	E-are called safety precautions

(D) Complete the following mini-dialogue:

H: why.....?

T: the welder must use his mask to save his eyes

S: why must the fitter use a machine with guards?

L:.....

(E) Translate into Arabic:

Men working with machines, sharp tools, motors, electricity or inflammable material must always be careful and always on guard.

Translate into English:

يكثر تكرار وقوع الحوادث عندما نكون مرهقين قرب نهاية يوم العمل.

(F) Composition:

Write about seven lines on: safety precautions.

Safety rules(2)

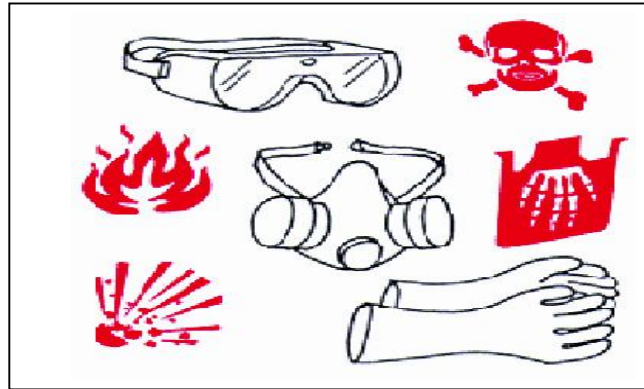

In order to take precautions, here are few points which will remind you to think before you act.

Please, read them carefully for your safety.

1-Be sure that you are not wearing any loose clothing which may flap or get caught up in moving machinery.

2-Long hair is also a menace if a worker is bending forward while concentrating on a machine.

3-when using metal removing machines it is wise to protect the eyes by wearing goggles or glasses. These prevent flying metal chips from entering the eye.

4-Always check metal plates for sharp or burred edges. These burrs are very sharp and can cause nasty cuts in the fingers if they are carelessly handed.

5-Never handle electrical switches when your hands are wet. Water may conduct electricity which makes it possible to receive a nasty shock or burn. Make certain that your hands are dry.

6-take care that the bench-saw, grindstone or vice that you are using is attached in its proper place. If it is not attached to the bench beware it may be on your foot next. A weight dropped on to the foot can cause a nasty accident.

7-Never pick up a plate unless you are certain that it is cold. Many burnt fingers result from doing just this.

8-Never use fingers to test "burning" plates or stoves for heat capacity. An easy way to test it is to drop a few drops of water onto the edge

9-The handling of wet metal plates can cause floors to become slippery.

10-Never lean on a machine or other equipment.

11-If you have cuts or scratches on your hands, then keep them out of the machine or else wear gloves.

A-some of the following instructions are wrong. Put a cross (X) by those that are wrong:

- 1-Do not wears goggles or glasses when using metal removing machines.
- 2-Never handle electrical switches when your hands are wet.
- 3-Slippery floor may harm you.
- 4-Be sure that you are not wearing loose clothing.
- 5-Long hair is not a threat when bending forward while concentrating on a machine.

B-Answer these questions:

- 1-What is your motto in the workshop?
- 2-How can you test burning plates?
- 3-Is water good or bad conductor of electricity?
- 4-Should you handle electrical switches when your hands are wet? Why?
- 5-Can a slippery floor cause bad fall?

C-Complete from the list:

(gloves-ventilation-safe- helmet- goggles- a tie- machines- overalls- bench- eyes- instructions)

- 1-We must use.....to protect our eyes.
- 2-Enough.....in the workshop help us avoiding accidents.
- 3-You should follow the instructor's
- 4-We should keep tools in the drawer of the.....
- 5-To protect your hands you must wear.....
- 6-Put your hands away from moving.....
- 7-Wearing a protect your head.

8- We must follow safety rules to be.....

9-We should wearin the work shop.

10-We mustn't wear.....during the work.

D-composition:

Write about seven lines about

(a)Safety rules.

(b) Avoiding work accident

Grammar

Direct and Reported speech

Direct speech:

Ex.: Seif says to me, " I love football."

Reported speech:

Seif tells me that he loves football.

Statements

Nancy said to me, " I visited Dalia today. "
(Direct speech)

Nancy told me that she had visited Dalia that day
(Reported speech)

1-Change said to into told but said still as it .

2- delete the comma and speech marks , join with (that) or not.

3- Change the pronouns .

4- Change the tense to the past .

* Do not Change the tense if the verb is in the present.

Ahmed says to me," I will send the fax."

Ahmed tells me that he will send the fax.

He says," I am very happy today."

He says that he is very happy today.

He said," I am very happy today."

He said that he was very happy that day.

مباشر	غير المباشر	مباشر	غير المباشر
Go Is going Has gone\have gone	Went Was going Had gone	Went Was going\were going Will go	Had gone(went) Had been going (was\were going) Would go

Ex.

-Adel says to me," I have a new computer."

Adel tells me that he has a new computer.

-Hany said to me," I studied all my lessons."

Hany told me that he had studied all his lessons.

-Sara said to me," I have bought a new mobile phone."

Sara told me that she had bought a new mobile phone.

Practice

1-Ramy said to me," I scored two goals."

Ramy told me that he had scored two goals.

2-Ahmed said to me that he could swim fast.

Ahmed told me that he could swim fast.

3-Hadir said to me," I have written the letter."

Hadir told me that she had written the letter.

مباشر	Direct	غير مباشر	Indirect
Now		Then	
Today		That day	
Tomorrow		The next day\the following day	
Yesterday		The day before	
Next week		The following week	
Last year		The year before	
Ago		Before	
This		That	
These		Those	
Here		There	

Exercise

1-Choose the correct answer:

1-sayed said that he.....to Cairo the day before.

- a) had gone b)goes c)go d)going

2-mariem.....she had finished her work an hour before.

- a) told b)said c)asked d)advised

3-she.....her father had been abroad

- a) told b)said c)asked d)asked me

4-Ramy said that his father.....to London the next day

- a)travelled b)will travel c)would travel d)travels

Rewrite the following sentences using the word(s) in brackets to give the same meaning:

1-Ashraf said to me, " I invite you to my birth day party" (Ashraf told me..)

2-"we're taking fish from New York to Rome," the sailor said (that)

3-Wael said to me " I've just bought a new car." (told)

4-Faried said to Noha , " I am in hurry." (Faried told..)

5-" I'm tired and I want to sleep," Huda said (Huda told her mum)

6-Nadia said, " I am coming home at six." (Nadia said that)

7-Adham said, " I am doing my homework." (Adham said that)

Safety rules (3)



Common sense teaches us to take good care in avoiding mechanical dangers in the use of any tools or machinery. A flame on a hot plate can burn fingers. A blade can cut its user. Flying chips from metals can find their way into the eyes. Fingers and even hands can be caught in an unguarded press cylinder. A slippery floor can cause a bad fall.

Before you use any machine, equipment or even any tool in the workshop, you should listen to your instructor's instructions in order to avoid accidents. So here are a few points which will remind you to think before you act.

Please, read them carefully for your safety in the workshop:

- 1-Don't leave tools on the workbenches.
- 2-Don't run in the workshop, always walk.
- 3-Don't bring food or drinks into the workshop.
- 4-Pick up all objects from the floor and put them away.
- 5-Clean up liquid from the floor.
- 6- Wear overalls at all times.

- 7-There must be a fire extinguisher in the workshop.
- 8-There must be safety helmets in the workshop.
- 9-There must be guards on all grinding machines .
- 10-Every workshop must have a fire alarm which works.
- 11-Safety goggles must be worn when using the grinding machines.
- 12-Keep tools in the tool board, don't leave them on the bench.



(A) Giving and responding to warnings:

Ex.: 1-(A): Look out!

(B) What is it?

(A) There is water on the floor. You can have a bad fall.

(B) Thanks

Use these words: injure burn, get a shock, bump, explode, get a puncture, cut.

(a) knife/hand

(c) holes/pipe

(b) ladder/wall

(d) fire/workshop

(B) Complete the following mini-dialogues:

1- Mr. Emad: what should we wear during welding?

Samy: It's necessary to.....

2-Mr. Emad: why.....?

Hany: we use very hard helmet to protect our heads.

3- Mr. Emad : why do we use goggles in the welding process?

Ali: goggles.....

(c) Translate into Arabic

Before you can use equipment and machines or attempt a practical work in a workshop, you must understand basic safety rules.

.....
.....

(d) Translate into English:

- تحمي القفازات يد العامل اثناء العمل.

.....

- يستخدم العامل الخوذه شديده الصلابه لحمايه الراس.

.....

- يجب ان يكون للماكيته غطاء ليمنع الاشتعال.

.....

- نظف الارضيه من السوائل او المياه حتي لا تتسبب في وقوعك.

.....

- لا ترتدي رابطه العنق او ملابس واسعه في الورشه.

Past perfect simple

Form: had + P.P

Usage:

Some thing happened in the past before another thing

Keywords:

after , before , when ,as soon as , until , till , by the time.

after / when /as soon as + ماضي بسيط ⇒ ماضي تام

After she had done the shopping, she returned home.

before/ by the time + ماضي بسيط ⇒ ماضي تام

Before she returned home , she had done the shopping.

till/until + ماضي تام ⇒ ماضي بسيط منفي

She didn't return home until she had done the shopping.

Rewrite the following sentence using the word between brackets:

1-He washed his feet carefully. Then he put his shoes on. (Before)

2-he completed the letter. Then he had a cup of coffee. (Until)

3-First they ate chicken. Then they fell ill. (As soon as)

Unit

(6) Measurements

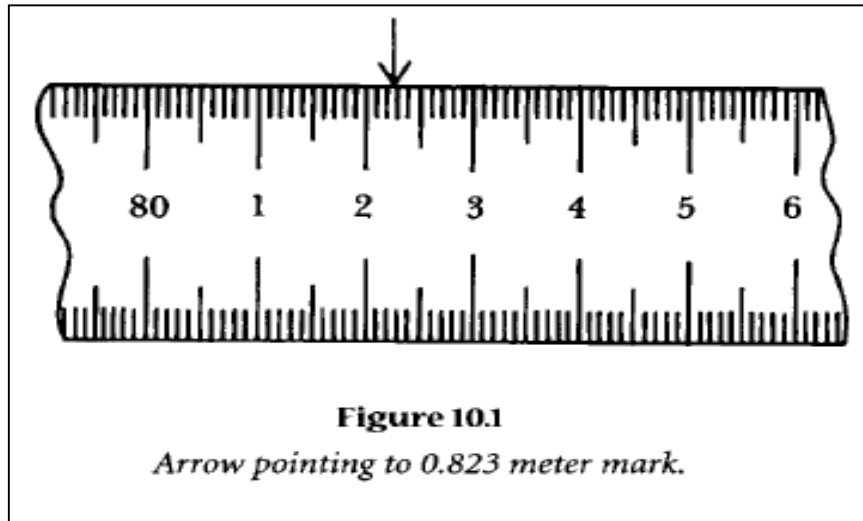

Aims of the unit

- . Measurements tools.
- . Expressing different dimensions.
- . ways of measurements.
- . How + adj - what + noun.

Unit(6)

Measurements



Read the following conversation then answer the questions:

Mrs. Eman is discussing the measurements and dimensions with her class.

Mrs. Eman: measuring things help us to do our work accurately.

Student 1: what are the common tools which we use to measure objects?

Mrs. Eman : they are the tap measure, the vernier caliper(the micrometer) and the ruler.

Student 2: Is there any thing else?

Mrs. Eman: yes, we can consider the balance one of them.

Student 3: what about the watch?

Mrs. Eman: good, it's used to measure the time.

Student 4: could you tell us what is the dipstick?

Mrs. Eman: well, it's a dial rod which used to measure the depth.

Student 5: what is the balance used for?

Mrs. Eman: it's used to measure the weight of both man and objects .

A-Answer the following questions:

- 1-What are the most common tools to measure things?
 - 2-How can we measure time?
 - 3-What is the tool of measuring depth called?
 - 4-Does the balance measure depth?
-

B-Put (T) or (F):

- 1-we use the meter to know the dimensions. ()
- 2-the ruler is the complex measuring tool ()
- 3-the dipstick is used to measure the depth ()
- 4-the watch is used for measuring weight ()

C-Practice this:

How What	high height	Is the	Building?	It's	60m	high height
How What	deep depth		Sea?		500m	deep in depth
How What	tall height		Young man?	He's	160cm	tall in height

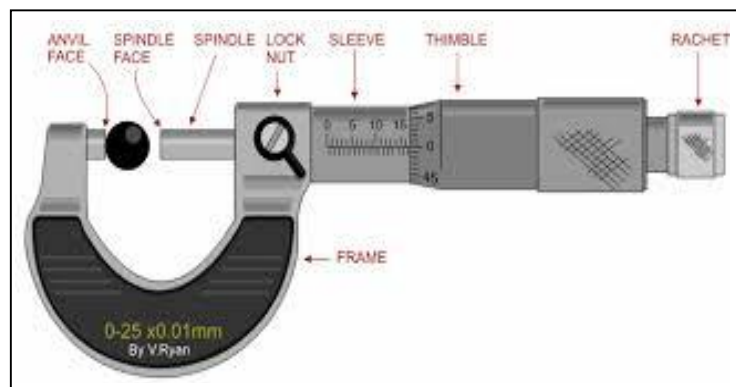

Note

1) How + adj. (How old/How high/ How deep/How long)

2) What + noun (What age/What height/What depth/What length)

D-Ask and answer using the words below:

(Road & wire & river & cabinet & box)

Example: (1)

A: how long is the wall?

B: it`s twelve meters long.

Or: it`s twelve meters in length.

Example: (2)

A: how high is the bridge?

B: it`s four meters high.

Or: it`s four meters in height.

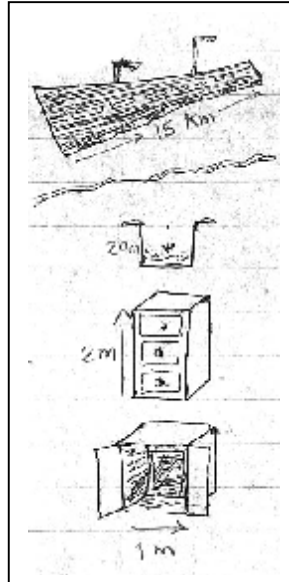

Note

M =meter
Mm= millimeter
G = gram
Kg = kilo gram
Km= kilo meter
Cm= centimeter

Write
3m

say
three meters

*Look at the difference (its and it`s)

-its length is fifteen kilometers.

It`s 15 kilometers long.

It`s=it is

*Study the following idioms carefully:

Thick- square- cubic- volume- frame- area-diameter- dimension- thickness - long-
high- deep- length- height- depth- heavy- weight- circular- rectangular

Triangle- rectangle- triangular- circle- oval- (semi-circular)- maximum- approximately

Part (2)

A-Listen and repeat:

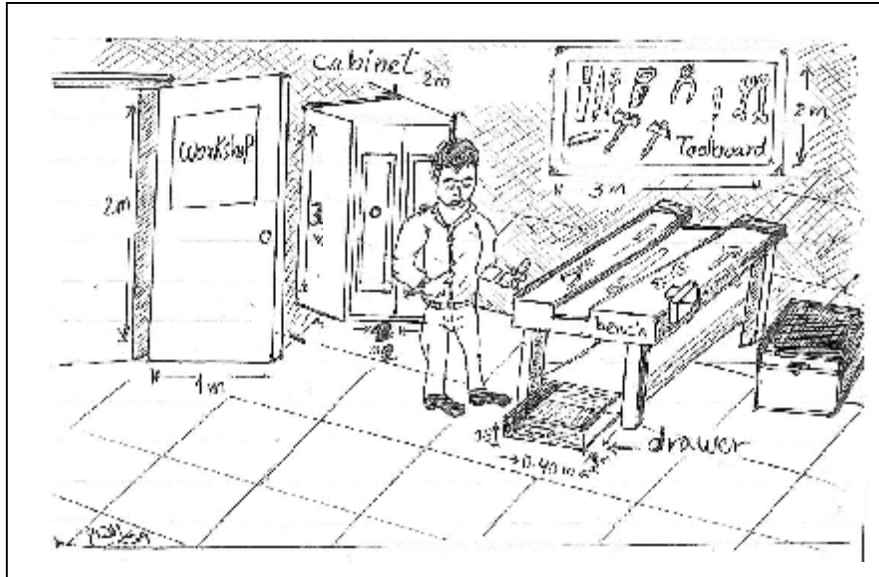

1-The door is 1m by 2m.

Or- the door is 1 by 2 meters.

So- the area of the door is 2 square meters.

2-The cabinet is only 2 by 2 by 3 meters.

So- the volume of the cabinet is 12 cubic meters.

3-The tool board is 2m by 3m.

So- they are of the tool board is 6 square meters.

B-Study and practice this:

Write it like this	Say it like this
5m×6m× 7m	.five meters by six meters by seven meters .five by six by seven meters
Area: 30m Volume:20m	.thirty square meters in area .twenty cubic meters in volume
6,435 6.526 1.01	.six thousand, four hundred and thirty five .six point five two six .one point oh one Or, one point zero one

C-Look at the picture (a) part 2 then ask and answer:

*Example:

A: What are the dimensions of the door?

B: its height is 2m and its width is 1m.

S: What are the dimensions of the cabinet?

N:

L:

M: it`s height is 2m and its width is 3m.

D-Measure objects in your class(you can guess their dimensions)

then make sentences like the following example:

(1)-the length of the class is about ten meters.

-it`s width is about 6 meters.

-it`s height is about 4 meters.

-that`s ten by six by four.

-so the volume of the class is about 240 cubic meters.

- | | |
|----------------|----------|
| (A) Door | (area) |
| (B) Box | (volume) |
| (C) Blackboard | (area) |
| (D) Cabinet | (volume) |
| (E) Table top | (area) |
| (F) Drawer | (volume) |

(E) Match the following:

(A)

4m 5m 6m

4.653

Volume: 60m

1.01

area: 20m

(B)

twenty square meters in area

one point oh one

four point six five three

four m by five m by six m

sixty cubic meters in volume

(F) In pairs, read out and solve the following sums (you may use a calculator)

*Example:

A: add 25 and 30

B: 25 plus 30 = 55

A: subtract that from 95

B: 95 minus 55 = 40

A: now multiply 40 by 2

B: 40 times 2 = 80

A: and divide that by 4

B: 80 divided by 4 = 20

A: multiply 94.5 by 5 and divide the answer by 10

B: divide 40.5 by 5 and multiply the answer by 8

C: add 22.8 to 33.2 and subtract 32 from the answer

D: subtract 39.35 from 58.02 \add 3.57 subtract the answer from 70.9

E: add 346.09 to 62.82 and subtract the answer from 537.42



(G) Rewrite the following sentences to give the same meaning begin the new sentences using the words given:

Example (a)

*The floor of the work shop has an area of 85 square meters.

1: the floor of the work shop is 85 square meters in area.

2: the area of the floor of the work shop is 85 square meters.

Example (b)

*The van has a volume of 12 cubic meters.

1: the van is 12 cubic meters in volume.

2: the volume of the van is 12 cubic meters.

(C) The class is 185 cubic meters in volume.

1: the class has.....

2: the volume of.....

(D) The area of the play ground is about one acre.

1: the play ground has.....

2: the play ground is.....

(E) The volume of the bottle is 1.5 liters.

1: the bottle is.....

2: the bottle has.....

(F) The door of the class has an area of 2 square meters.

1: the door of the class is.....

2: the area of the door of the class is.....

(H) Composition:

Write seven lines about only one subject:

(A) Measurements

(b) dimensions

(I) Translation

Into Arabic

We use many measuring tools in our daily life such as the tap measure, the venire caliper and the rule.

Into English

تستطيع ان تحسب حجم المكعب بقياس الطول و العرض والارتفاع

Complete the following mini dialogue:

(1)

A: How.....building?

B: It`s 15 meters high.

(2)

A: What.....the entrance?

B: It`s width is 3 meters.

(3)

A: How..... the windows?

B: They are 2 meters high.

(4)

A: What.....the road?

B: It`s 15 kilometers long.

Read the following text then answer the questions below:

A foot ball field must be rectangular for international matches, the maximum length of the field is 110 m, and the maximum width is 75 m.

There is a goal at each end of the field. Each goal is about 7.3m wide and 2.4m high.

Each side of the football field has a goal area and a penalty area. The goal area is rectangular and has a length of approximately 18 m. the penalty area is also rectangular and approximately 40 m long.

The ball is made of leather. It`s maximum weight is 454 g.

Answer these questions:

1-How long and how wide is a football field?

2-What is the shape of the football field?

3-How heavy is a football?

4-What is the length and what is the width of the goal?

Communications

Telling the time

Study this carefully and practice the sentences:

-What's the time?

It's two o'clock

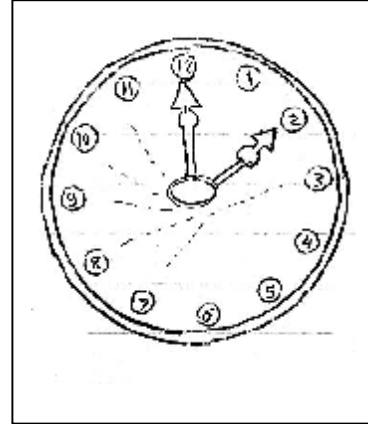

In pairs, ask your partner the time:

Example:

M: what is the time?

Or: What time is it?

S: it's quarter past six in the morning.

- (a) 05.15 (f) 10.25
- (b) 13.45 (g) 21.30
- (c) 12.00 (h) 01.35
- (d) 08.55 (i) 11.50
- (e) 17.05 (j) 20.40

Morning	Afternoon and evening
Write 06.30 6.30 a.m	18.30 6.30 p.m
Say six thirty in the morning. Half past six in the morning.	Six thirty in the evening. Half past six in the evening.
18.30 uses the 24-hour clock. (12.00 + 6.30= 18.30)	

Copy and complete this diary. You can change it and write true information about your self. Then ask and answer with your partner:

Example:

A: What time do you wake up?

B: I wake up at six o'clock in the morning.

My day	
Activity	Time
Wake up	06.00.....
Go to school	07.00.....
Eat lunch	15.00.....
Finish school
Arrive home
Eat dinner
Meet my friends
Go to bed

Revisions & Exams



Revision

Read the following passage then answer the questions:

A great change has come upon my village. It is no longer dark at night as the streets are brightly lit up. As a matter of fact, a new life has been breathed in it and the standard of living is rising. My village is fortunate enough to have a health unit which renders free medical services. Villagers pass a pleasant time in the club where they can watch good television programmes.

A-Answer these questions:

- 1-what is the great change that happened in the Egyptian village?
- 2-Does the standard of living rise?
- 3-when do the villagers pass their free time?
- 4-What can they watch there?

B-choose the correct word:

- 1-My grandfatherto get up early.
(Used –using – uses - use)
- 2-The.....is used to send e-mails.
(Metro –telephone – computer -book)
- 3-Nowadays, I can see a big number of.....channels
(Service - songs -satellite- saving)
- 4-Computers are fast and.....
(Accurate -memory- store- e-mail)

C-Rewrite the following sentences using the words between brackets:

- 1-I wrote many letters when I was young. (used to)
- 2-We enjoy our lunch. (now)
- 3-Study hard and get high marks. (If)
- 4-Yesterday she washed the clothes. (Tomorrow)

D-Complete the dialogues:

A:Can the internet be dangerous?

B:.....

S:.....?

M:Yes, the bus used to take along time in the past.

Revision

(A) Answer the following:

- 1- Computers are very useful, Give two reasons.
- 2- Do you consider "computer is one of the wonders of the modern world"?
- 3- In your opinion, what's the most important-invention?
- 4- Do you think that inventions have brought people-only-problems?

(B) Tick (T) or (F) :

- 1- Telephones help us to communicate ()
- 2- Computers are used widely in factories ()
- 3- Edison is one of the most popular inventors ()
- 4- The internet is part of everyday life for most people ()
- 5- You can buy anything online ()

(C) Choose the correct answer :

- 1- They ----- their lunch now.
(are having – have – had - will have).
- 2- Salwa -----tomorrow.
(arrive - is arriving - arrives - arrived).
- 3- Rania ----- visit me next week.
(will - can - have - could).
- 4- My uncle ----- there for seven years.
(Worked - has worked – will work - working).
- 5- She has ----- in Cairo since 2002.
(live - living - lived - lives).

(D) Translate into Arabic:

- 1- Modern inventions have brought much happiness.
- 2- Computers store information about everything.

Translate into English:

- في الحقيقة ان الحاسبات الاليه تقوم بعمل ما يطلب منها فقط.
- في هذه الايام يستخدم كثير من الناس الانترنت في كثير من مجالات الحياه.

Revision

A: complete these mini-dialogue:

1)

S: What are.....?

M: its height is 2.25m and its width is 1m.

2)

H: What's the time?

N:.....

B: complete the sentences using a word from the list:

(diameter- length- long- cubic- square- dimensions)

1-the van is 12.....meters in the volume.

2-what are the.....of the door?

3-the.....of the circle is 115.15mm.

4-the are

5-the.....of the wall is about 12 meters.

C: Rewrite the following sentences using the word between brackets:

(1)How long is the wall? (What)

(2)What's the depth of the sea? (How)

D: Read the following passage then answer questions:

Mo`men is 15 years old. He is 165 cm tall and weighs 60 kg. he goes to bed at about 10.00 every night, and gets up every morning for school at 6.30. Every morning before break fast he does some exercises to be fit. At school he plays football every day. Every Thursday he goes to the club and swims 20 lengths in the swimming pool this takes him 10 minutes. The pool is 50m long. Every Friday he goes to the sports field and runs around the track six times in ten minutes. The track is 400 m long.

(1) Answer the following questions:

A-How old is Mo`men?

B- What does he play at school?

C-When does he go to the sports field?

(2) choose the correct answer:

D- Mo`men is 165 cm.....

(Tall- long- wide)

E-the pool is 50m.....

(Length- deep- long)

E: Translation

Into Arabic

To do our work accurately, we should use the measurements tools.

Into English

تعتبر القدمة ذات الورنية و شريط القياس و قضيب قياس العمق من اكثر ادوات القياس شيوعا.

Revision

1-Write 5 lines on one of the following subjects :

A-Energy

B-inventions

C-computers

2-Answer the following questions :

A-What is the importance of the computer?

B-What kind of fuel does a car need to make it runs?

C-Are there any alternatives to nuclear powers.

D-Do you see satellite channels? Which one?

E-Mention some forms of renewable energy?

3-Underline the correct word :

A-Gana.....travel to Paris next month.

(Shall-will-does)

B-Mo`men lives.....Giza.

(at-on-in)

C-I`ve lived in Embaba.....2002

(for-since-yet)

D-Sama is.....clever as Yara.

(As-so-if)

4-Translation : Into Arabic

Nothing can live without energy.

Into English

بالرغم من ان الاختراعات جلبت السعادة للانسانية فانها جلبت بعض المتاعب ايضاً.

Revision

1-Write about seven lines on one of the followings:

1-The importance of the computer. 2-Safety precautions.

2-Answer these questions:

1-What do you need to use the net?

2-How can you test burning plates?

3-What are computers used for in hospitals?

4-Is water good or bad conductor of electricity?

5-What should you wear to protect your eyes in the workshop?

3-Choose the correct answer:

1-Don't in the workshop.

(run- fun – jump)

2-The dipstick is used to measure the.....

(length-depth-width)

3-..... and light are necessary elements in the workshop.

(Bench – Ventilation – Darkness)

4-Don't use the machine with no.....

(guard-problem-person)

5-Edison invented the.....

(Computer-lamb-car)

5-Match:

(a)

1-Wear gloves

2-wait for the

3-Computer sometimes

4-In factories

5-The micrometer

(b)

a-forget information

b-computers control robots

c-is one of the measurements

d-teacher's instructions

e-to protect your hands

Translation

A-Into Arabic:

- Make certain that your hands are dry before handling electrical switches .water conducts electricity.
- Life in Cairo today is different than before.
- I can send e-mail from my computer.
- The inter net becomes part of everyday life for everyone.
- We owe very much to the inventors.
- Listen to your instructor before using any machine.
- The internet may be dangerous if you use it incorrectly.

B-Into English:

- يعتبر الانترنت وسيله عظيمه لتعلم اشياء جديده كثيره.
- اعتاد جدي ان يذهب الي العمل ماشيا.
- يجب ان تستخدم الخوذه الصلبه لحمايه الراس في العمل.
- من وسائل القياس الشائع شريط القياس و الميكرو متر.
- اخترع الامريكيين الاخوان رايت اول طائره.
- لقد جعلت الاختراعات حياتنا اكثر سهوله.

Model Exam (1)

A) Write a short paragraph on one of the following

- 1-the internet and it`s importance.
- 2-The forms of energy and their uses.
- 3-One of the inventions you like best.

B) Match:

A

- 1-Most cars
- 2-The sun and the water
- 3-Computers store
- 4-Thomas Edison
- 5-We send e-mails

B

- A-are forms of energy
- B-is a great inventor
- C-use petrol
- D-through the internet
- E-huge amount of information
- F-use the wind

C- Put (T) or (F)

- 1-the inventions make our life easier ()
- 2-sometimes computers forget information ()
- 3-world population causes crisis ()
- 4-nuclear power is very important ()
- 5-people can shop and study by computer ()

D- Translation: Into Arabic

In banks computers store information about people`s money.

Into English

نحصل علي الضوء و الحرارة من الطاقة الشمسية.

Model Exam (2)

A-Complete the following –mini dialogue

1-Adel: Do you think that computers are useful?

Samy:.....

2-Nagwa:?

Yehya: the sun, the water and the wind are renewable forms of energy.

B-Choose the correct answer

1-we should.....the amount of non-renewable fuels.

A-waste

B-reduce

C-increase

2-people use computers to send.....through the net.

A-E-mail

B-books

C-money

3-An.....is a discovery or new way to make something.

A-internet

B-invention

C-international

4-Nuclear energy is very.....

A-clean

B-clever

C-bad

C-Read the passage then answer the questions below

Television is one of the most important inventions. It was invented to bring people news and interesting information. It teaches them new things and shows them-also , places they never visit.

Questions:

1-What does TV bring people?

2-What does TV show people?

3-Do you think that television is important?

D-Rewrite the following sentences using the words between brackets

- 1) she studies hard and gets high marks. (If)
- 2) yesterday, they visited the citadel. (Tomorrow)
- 3) samya has already done her homework. (Yet)
- 4) We play football every day. (Now)

E-Translation

Into Arabic

- *computers help us in factories, schools, hospitals and at home.
- *there are a lot of advances in the field of inventions.
- *the world must reduce the amount of non-renewable energy.

Into English

- *هناك بدائل كثيرة للطاقة النووية.
- *تعتبر الشمس اهم مصدر للطاقة المتجددة
- *جلبت الاختراعات الحديثة الكثير من السعادة للانسانية.

Vocabulary



Vocabulary

discuss	يناقش	long	طويل	مستطيل الشكل
measure	يقيس	tall	طويل للانسان	مثلث الشكل
measurement	قياس	high	عالي	شبه دائري
dimension	بعد	deep	عميق	تقريباً
accurate	دقيق	heavy	ثقيل	الحد الاقصى
accurately	بدقة	thick	سميك	لوحة حفظ العدد
common	شائع	triangle	مثلث	Tool board
object	شيء	rectangle	مستطيل	bench
tap measure	شريط قياس	circle	دائرة	درج
	قدمة ذات ورنية	cubic	مكعب	رف
Vernier caliper		square	مربع	يخمن
consider	يعتبر	area	مساحة	يحل
balance	ميزان	volume	حجم	مسألة حساب
depstick	مقياس للعمق	weight	وزن	الة حاسبة
rod	قضيب	height	ارتفاع	يضيف
dial	مدرج	length	طول	علامة الجمع
bridge	كوبري	depth	عمق	يطرح
cabinet	دولاب صغير	width	عرض	علامة الطرح
wire	سلك	thickness	سمك	يجري عملية ضرب
road	طريق	frame	اطار	Multiply
acre	فدان	diameter	قطر	يجري عملية القسمة
entrance	مدخل	circular	دائري	Divide
playground	فناء	atmosphere	غلاف جوى	النتائج
energy	طاقة	oval	بيضاوي	
		van	سيارة نقل صغيرة	

vital	اساسي - حيوى	unwell	غير راغب - لايريد
natural	طبيعي	several	عديد
source	مصدر	spring	عين ماء
last (v)	يدوم - يستمر	promising	واعد - مبشر
forever	للابد	solution	حل
wind	الرياح	crisis	ازمات
renewable	متجدد	percentage	نسبه مئويه
non renewable	غير متجدد	nation	أمة
run out	ينفذ - يستهلك	needs	احتياجات
reason	سبب	satisfy	يكفي
reduce	يقلل - يخفض	rate	معدل - نسبه
amount	كميه	experiment	تجربه
rubbish	قمامة	avoid	يتجنب - يتلاشي
connect	يتصل	danger	خطر
generate	يولد	protect	يحمي - يقي
nuclear	نووي	environment	بيئه
atomic	ذري	west	يضيع - يفقد
produce	ينتج	extensively	بتركيز
expensive	غالي	efficient	كفاء
turn into	يتحول الي	human being	البشر - الانسان
save	ينقذ - يحمي - يوفر	memory	ذاكره
turn off	يطفى	store	يخزن
recycle	يعيد تدوير	calculation	عمليه حسابيه
expert	خبير	fraction	جزء
believe	يظن - يعتقد	alive	علي قيد الحياه - حيا
serious	جاد	sum	مسألة - مبلغ مالي
shortage	نقص	second	ثانيه
population	عدد السكان	pay	يدفع

individual	فردى	wage	راتب - اجر
standard	مستوى	reserve	يستحق
explosion	انفجار	seat	مقعد
search for	يبحث عن	send	يرسل
suitable	مناسب - ملائم	examine	يفحص
alternative	بديل	patient	مريض
pure	نقى	wonder	عجيبه
pollute	يلوث	accurate	دقيق
flexible	مرن	communicate	يتصل
huge	ضخم	the same	نفس - ذات
forget	ينسى	problems	مشكلات
across	عبر - خلال	happiness	سعاده
bill	فاتوره	lazy	كسول
certainly	بالتأكيد	instead of	بدلا من
concern	يهم	news	أخبار
completely	تماما	information	معلومه
extremely	بشده	enormous	ضخم - هائل
feed	يغذي	advance	تقدم
servant	خادم	design	يصمم
master	سيد	recharge	يعيد شحن
decide	يقرر	farther	أبعد
it's up to----	يتوقف علي - الامر مرهون ب	empty	خالي - فارغ
web	شبكة عنكبوتيه	ordinary	عادل
site	موقع	run on	يعمل ب - يدور
around	حول	cheap	رخيص
locate	يقع	unique	فريد - متميز
specific	محدد	solar	شمسى
in charge of	مسئول عن	man-made	من صنع الانسان

provide	يُمد - يوفر	advantage	ميزه
free	مجاني	disadvantage	عييب
enable	يمكن	bring	يجلب - يحضر
log onto	يتواصل مع - يدخل علي	form	تكوين - شكل
world wide web	الشبكة العنكبوتيه العالميه	boring	ممل - كئيب
educational	تعليمي	channel	قناة تليفزيونيه
everyday	يومي	agree	يوافق
fun	متعه - مرح	disagree	يعترض
careful	حريص	invention	اختراع
claim	يدعى	opinion	رأي
personal	شخصي	chat	يبردش
address	عنوان	permission	تصريح
parents	الاباء - الوالدين		
grandfather	جد	want	يريد
used to	اعتاد ان	change	يغير
walk	يمشي	switch on	يشغل
post office	مكتب بريد	ride	يركب
through	خلال/عبر	Drive	يقود
later	فيما بعد	theater	مسرح
almost	تقريبا	village	قرية
favorite	مفضل	neighbor	جار
singer	مطرب	mobile	متنقل/نقال
manager	مدير	e-mail	بريد الكتروني
office	مكتب بريد	seconds	ثواني
air conditioner	تكيف هواء	desert road	طريق صحراوي
international	دولي	satellite	قمر صناعي

filling cabinet	دولاب حفظ ملفات	channel	قناة تليفزيونية
take a taxi	يركب تاكسي	modern	حديث
nowadays	هذه الايام	fan	مروحة
hourse	حصان	slow	بطئ
receive	يتسلم		
safety	الامان	for ever	الي الابد
always on guard	دائما حريصين	is turned of	مقطوع
accident	حادثة	machinery	معدات ميكانيكية
welder	لجام	moving parts	الاجزاء المتحركة
uncomfortable	غير مرتاح	mind	عقل
check	يلاحظ- يختبر	strike match	يشعل ثقاب
to handle	ان يتناول	more frequently	اكثر تعودا
guard	حاجز	smoke	يدخن
inflammable	قابل للالتهاب	brain of the machine	عقل الماكينة

avoid	يتجنب	suddenly	فجأة
precautions	احتياطات	be ware	احذر
mask	قناع	weight	ثقل
a flam	لهب	drop (n.)	نقطة
burn	يحرق	drop (v.)	يسقط
blade	سلاح	slippery floor	ارضية منزلقة
flaying chips	الرايش المتطاير	harm	اذي - ضرر
slippery	منزلق	equipment	معدات
remind	يذكر	cuts	جروح
cylinder	اسطوانة	scratches	خدوش
common sense	حاسة الادراك	rubber gloves	قفازات مطاط
loose clothing	ملابس واسعة	flap	يرفرف